

 **Polaroid TWO**

Instant Digital Camera

Quick Start Guide



Questions? Need some help?

This quickstart guide should help you understand your new product.

If you still have questions, call our help line found on the insert with this icon:



Or visit www.polaroid.com/support.

Digital Quality, Polaroid Simplicity™

For more information, consult the user manual on the included CD-ROM.

Product Overview

Front View

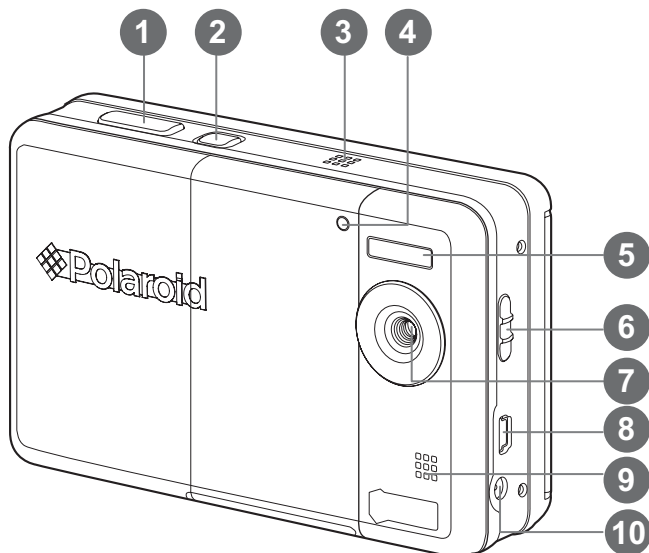

1. Shutter button
2.  Power button
3. Speaker
4. Self-timer LED
5. Flash
6. Focus switch
7. Lens
8. USB terminal
9. Microphone
10. DC IN 9V terminal

Rear View

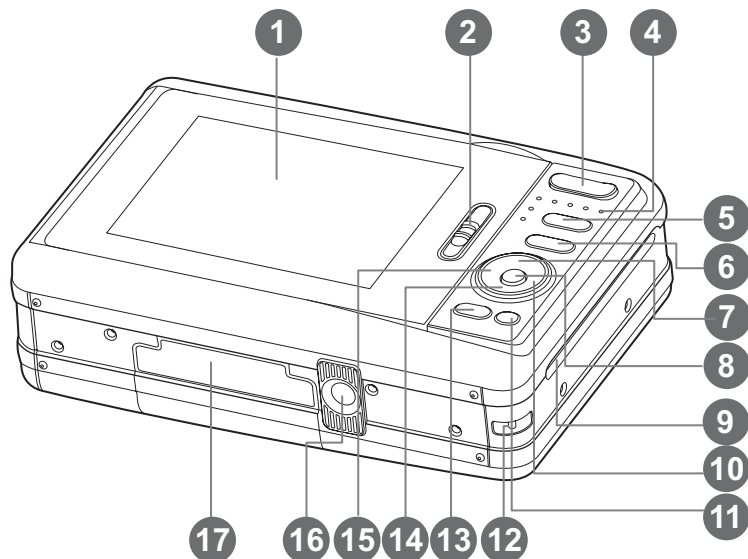

1. LCD display

2. Paper tray door latch

3. **T** Zoom in button
W Zoom out button

4. Status LED

5. **[Mode]** Mode button (Image capture and playback)

6. **[M]** Menu button

7. **[Up]** Up button
[Display] Display button

8. **[OK]** Set button

9. Photo exit slot

10. **[Right]** Right button

[Flash] Flash mode button

11. **[Delete]** Delete button

12. Hand strap holder

13. **[PRINT]** Print button

14. **[Down]** Down button
[SCN/Scene] Scene button

15. **[Left]** Left button

[Self-timer] Self-timer button

16. Tripod socket

17. Battery / SD card door

Getting Started

1. Attach the camera's hand strap as shown in the illustration.

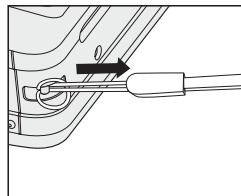

2. Open the battery/SD card door.
3. Insert the battery with tab uppermost as shown in the illustration.

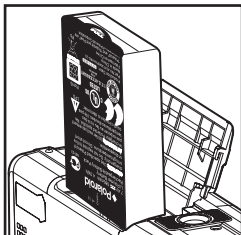

4. Insert an SD/SDHC memory card (Optional).
 - The camera has 16MB internal memory (4MB available for image storage), but you can load an SD/SDHC memory card (We recommend the use of a Polaroid SD card - purchased separately - up to 4GB) to expand the camera's memory capacity.
 - Be sure to format the memory card with this camera before its initial usage.
5. Close the battery/SD card door and make sure it is locked securely.

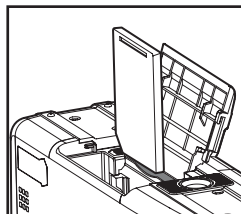

Charging the Battery

1. Insert one end of the AC power adapter into the DC IN 9V terminal of the camera.
2. Insert the other end of the AC power adapter into a wall outlet.
 - The status LED is orange when charging and is green when charging is complete.
 - Fully charge battery before first use (approximately 2 hours).

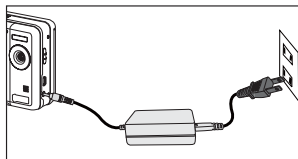

Installing Polaroid PoGo™ ZINK Photo Paper™

Insert the photo paper before printing images.

1. Slide the latch on the paper tray door as shown in the illustration.

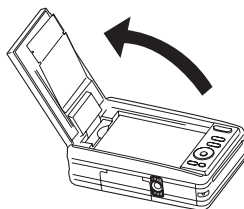
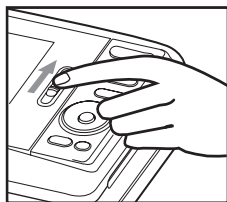

2. Unwrap the 10-pack of Polaroid PoGo™ ZINK Photo Paper™.

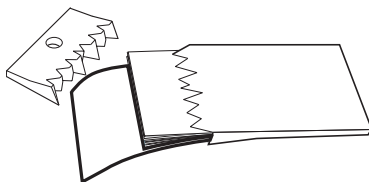

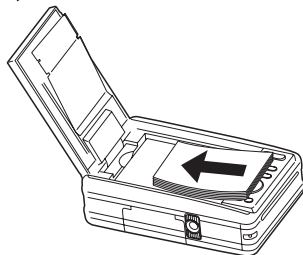

3. Slide the 10-pack of Polaroid PoGo™ ZINK Photo Paper™ into the paper tray.
 - Make sure the Blue ZINK Smart Sheet™ is placed and loaded with the bar code face down.
 - Shiny side of paper faces up.











4. Close the paper tray door.
 - The Blue ZINK Smart Sheet™ will automatically eject.

Turning the Camera ON and Off

1. Press and hold the  button to turn the camera on.
2. Pressing the  button again and the camera will shut off.



Choosing your Language

Specify what language in the menus and messages are to be displayed on the LCD display.

1. Toggle the  button to [] or [].
2. Press the  button.
3. Select [Setup] menu with the  button.
4. Select [Language] with the  /  buttons and press the **OK** button.
5. Select the displayed language with the  /  buttons and press the **OK** button.
 - The setting will be stored.



Taking a Picture



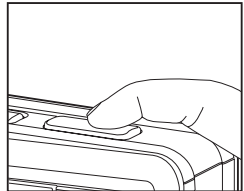

1. Set the focus switch to [] if you want to capture a close-up image (0.6 to 1.45m: 2 to 5 feet) otherwise set it to the normal setting [].
2. Compose your subject between the two horizontal lines on the LCD display. These two lines are the borders of the ZINK photo paper.
 - Should you want to zoom into your subject, press the **T** button and your subject will get bigger on the LCD display.
 - Pressing **W** button will provide a wide angle image.
3. Slowly press the shutter button until you hear the sound of the shutter.



Printing an Image

After reviewing your images you may want to print it.

Do the following:

1. Press the **PRINT** button.
2. Select [Print] with the  /  buttons, and press the **OK** button.
3. Select the image that you want to print with the  /  buttons.
4. Press the **OK** button and your camera will print the image on the screen.
5. If memory is full, not all the options are available.

That's all it takes!



For more information on how to use your new digital camera, please refer to your user guide found in the enclosed CD-ROM or visit www.polaroid.com. Please install Adobe® Acrobat® Reader™ in order to read the user guide.